

SILENT-200



Instrucciones de montaje
Instruction leaflet
Notice de montage
Montageanweisungen
Montage-en gebruiksaanwijzing
Instrucções para a montagem
Istruzioni per l'installazione
Användar instruktion
Brugervejledning
Instrukcja obsługi
Návod
Käyttöohjeet
Инструкции по сборке



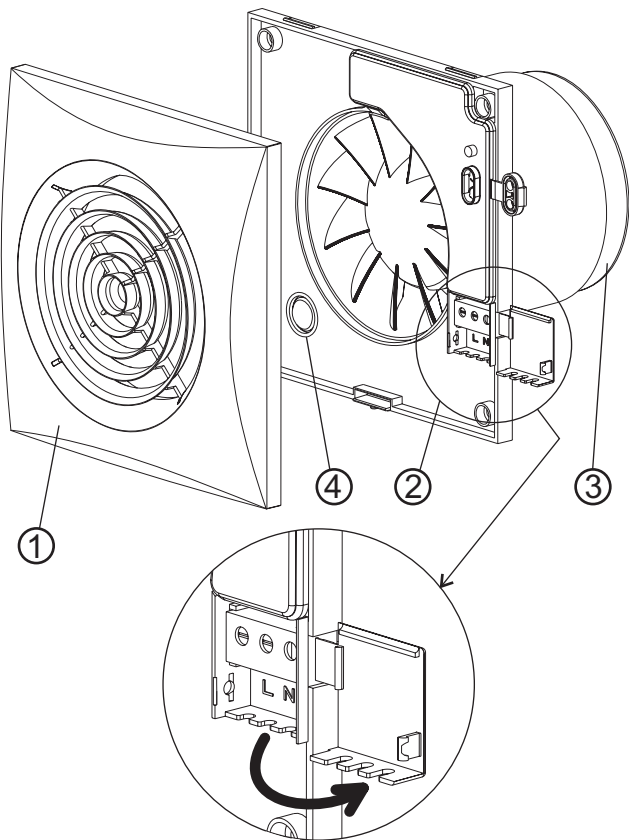

Fig.1

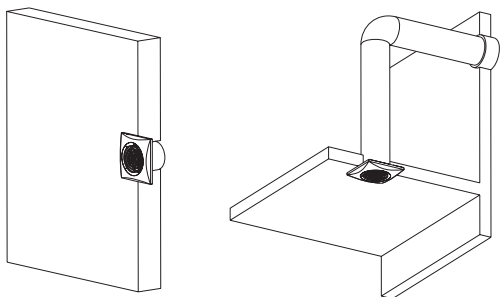

Fig.2

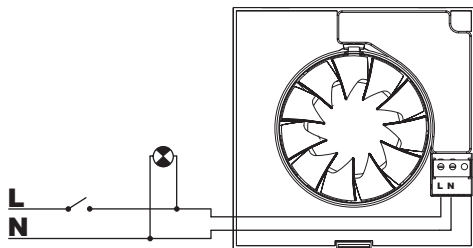

Fig.3

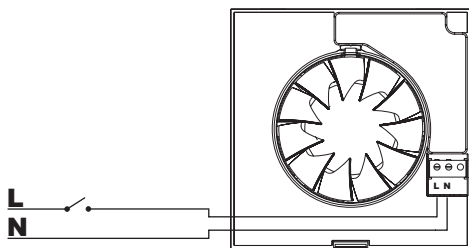

Fig.4

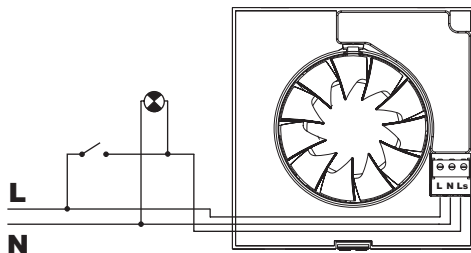

Fig.5

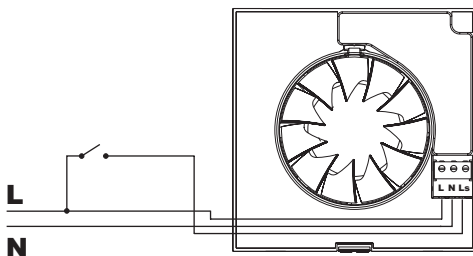

Fig.6

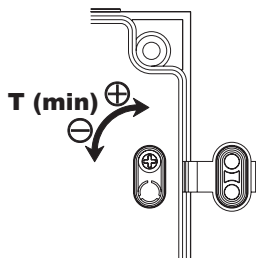

Fig.7

SILENT-200 CRZ

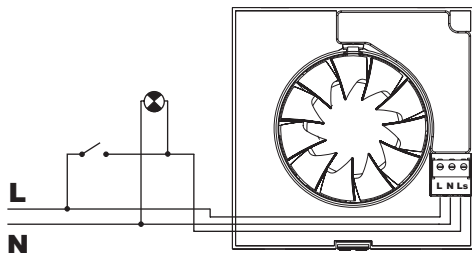

Fig.8

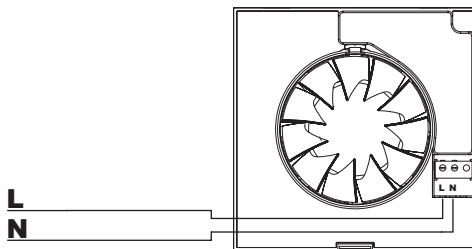

Fig.9

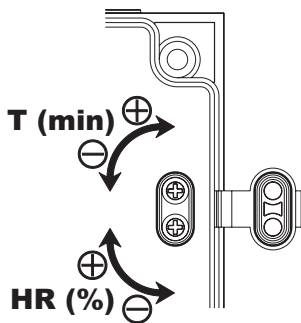

Fig.10

ENGLISH

SILENT-200 Axial Extractor Fans

The SILENT-200 extractor fan range is manufactured to the high standards of production and quality as laid down by the international Quality Standard ISO 9001. All components have been checked and every one of the final products will have been individually tested at the end of the manufacturing process.

- This appliance is not intended for use by young children or infirm persons unless they have been adequately supervised by a responsible person to ensure that they can use the appliance safely.

- Young children should be supervised to ensure that they do not play with the appliance.

On receipt of the product we recommend that you to check the following :

1- That it is the correct size.

2- That it is the correct model.

3- That the details on the rating label are those you require: voltage, frequency ...

The installation must be carried out in accordance with the electrical standards in force in your country.

Installation

IMPORTANT: Before installing and wiring the unit, ensure that the main supply is disconnected.

Precautions must be taken to avoid the back-flow of gases into the room from the open flue of gas or other fuel-burning appliances.

Fig. 1:

1: Protection grille

3: Outlet with backdraught shutter

2: Connection terminals

4: Cable entry

The SILENT-200 is suitable for wall or ceiling mounting and can either discharge directly to the outside or via an individual ducting system (see Fig. 2).

The unit can be mounted on the wall or ceiling using the 4 rubber blocks and the

screws provided.

Make a hole in the wall or ceiling of 125 mm dia.

If the unit is to be installed with individual ducting, use a standard 125 mm dia. duct. Ensure that there are no obstructions to the airflow and that the impeller turns freely.

Fix the extractor to the wall in such a way that it is not distorted in order to avoid noise generation or problems with the rotation of the impeller. Make sure that the backdraught shutter opens freely and has not being damaged in transit. Introduce the mains cable through the cable entry (4) and fix it to the wall.

Connect the electrical wiring as set out below and then mount the protection grille (1).

Electrical connection

The SILENT-200 is an extractor designed for a single phase supply, with voltage and frequency as indicated on the rating plate of the unit. The units are manufactured with double electrical insulation

(Class II) and therefore they do not need an earth connection.

The electrical installation must include a double pole switch with a contact clearance of at least 3 mm.

The electrical cable must enter the SILENT-200 through the cable entry (4).

Once the cable has been introduced proceed using the electrical wiring diagram applicable to the selected model.

SILENT-200 CZ

For these models use the following diagrams:

Fig.3: Switching the extractor through the light switch.

Fig.4: To switch the fan through an independent switch.

SILENT-200 CRZ

This model is provided with an adjustable over-run timer. The timer allows the fan to continue to operate for the selected period after the switch has been turned off (fig.6).

Model provided with a 4 positions adjustable electronic timer. Fig.5 shows how to connect the fan with timer utilising the same switch as for the lighting circuit.

To set the timer, turn the potentiometer on the printed circuit board as (fig. 7).

- To reduce the "run on" time, turn anticlockwise (min. 1 minutes)
- To increase the "run on" time , turn clockwise (max: 30 minutes).

SILENT-200 CHZ

Models provided with an electronic humidistat which can be adjusted from 60% to 90 % RH (relative humidity) and with a timer, adjustable between 2 and 20 minutes.

Operation

Case 1: Automatic operation (fig.9)

In automatic operation, the humidistat causes the extractor to operate automatically when the humidity level in the room is higher than the set level. The extractor will stop automatically when the humidity drops below the selected level and after the selected period set on the timer.

Case 2: Automatic operation as in case 1 with the facility to override the hygrostat by means of the light switch (fig.8), when the humidity level in the room is lower than the selected level. In this case, the extractor continues to operate for the selected period set on the timer after the switch light has been switched off.

ATTENTION: When the humidity rate is above the selected value, the automatic option takes precedence over the manual and the unit cannot then be switched off using a switch.

The desired humidity level is selected by means of a potentiometer "% Hr" positioned on the printed circuit board (fig.10) and accessible once the grille (1) has been removed.

- To increase the humidity setting turn anticlockwise (min.60 %)
- To reduce the humidity setting turn clockwise (max. 90 %)

To set the timer, turn the potentiometer "t min." on the printed circuit board (fig.10):

- To reduce the "run on" time, turn anticlockwise (min. 2 minutes)
- To increase the "run on" time , turn clockwise (max: 20 minutes).

Maintenance

The extractor fan only requires periodical cleaning using a cloth lightly impregnated with a soft detergent.

After Sales Service

We recommend you not to try to dismantle or remove any other parts than those mentioned as any tampering would automatically cancel the S&P guarantee. If you detect any fault, contact your S&P dealer.

S&P reserves the right to alter specifications without notice

Soler & Palau

Polígono Industrial Llevant
c/ Llevant, 4
08150 Parets del Vallès (Barcelona)
Spain
Tel. (34) - 93 571 93 00
Fax. (34) - 93 571 93 11
<http://www.solerpalau.com>



Ref. 0288274004
